

ÜRÜN KATALOĐU
PRODUCT CATALOG



monokon

MONOKON ELEKTRİK A.Ş.

2019 yılında Konya'da kurulan firmamız, 20 000 m² alanımızda yatırımlarına hızla devam ediyor. Üretim ve satış sonrası hizmet prosesini kaliteli bir şekilde sağlama ve uygun fiyat sloganıyla çıktığımız yolda, altyapımızı eksiksiz kurmak için 21 yıllık maddi, manevi birikimimizi kullanıyoruz.

Hedefimiz " Ne yaptığın değil; nasıl yaptığın " dan yola çıkarak, bizi satış sonrasında da temsil edecek ürünler yapmaktır. 21 yıllık tecrübemiz bize müşterisiyle ekip ruhu içerisinde çalışmayı öğretmiştir. Bunu sağlamanın yollarından biri, sürekli eğitim için programlı ciddi bütçe ayırdık. Yurt içinde kazandığımız bu tecrübeyi yurt dışında da kullanmak üzere altyapımızı hazırladık. 2020 yılı ürün çeşidiyle, satış ağıyla, fuarlarla yurt dışına açılma yılımız olacaktır.



MONOKON ELECTRIC INC.

Our firm, which was founded in Konya in 2019, is rapidly continuing its investments in our 20.000m² plot of land. With our goal and slogan of providing quality service process for production and post sales with adequate costs, we are utilizing our 21 years of experience with both material and moral background to establish a thorough infrastructure.

Our aim is to produce products that will represent us even after its sale, based on "It's not about what you did, it's about how you did it". Our experience of 21 years has taught us to work with our clients with a team spirit. One of the ways to provide this ,we've allocated a serious programmed fund for continuous education. We have prepared our infrastructure in order to employ this national experience we have acquired over the years to an international level. 2020 will be our year of expansion to abroad countries with various product types, sales network and fairs.



ÜRETİM

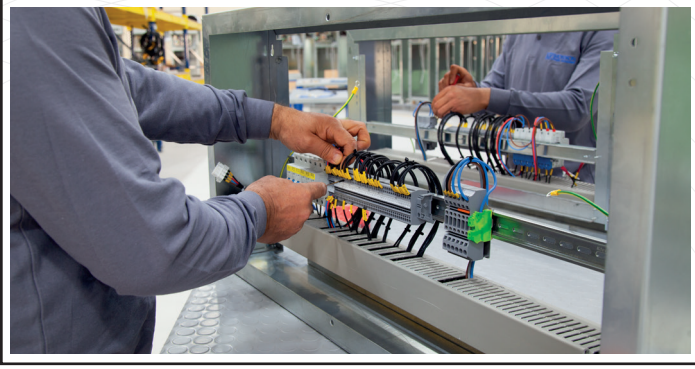

PRODUJOT

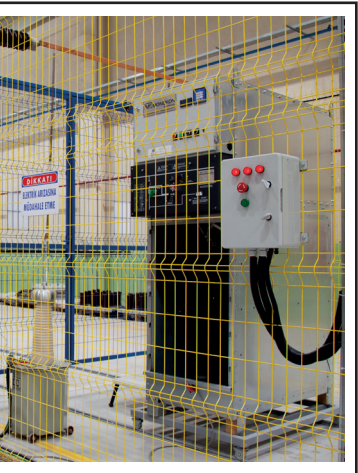

MODÜLER
HÜCRELER

HAVA İZOLELİ
METAL MAHFAZALI



MH SERİSİ (MH SERIES)

7,2 - 36 kV / 630 - 1250 A / 16kA - 1sn

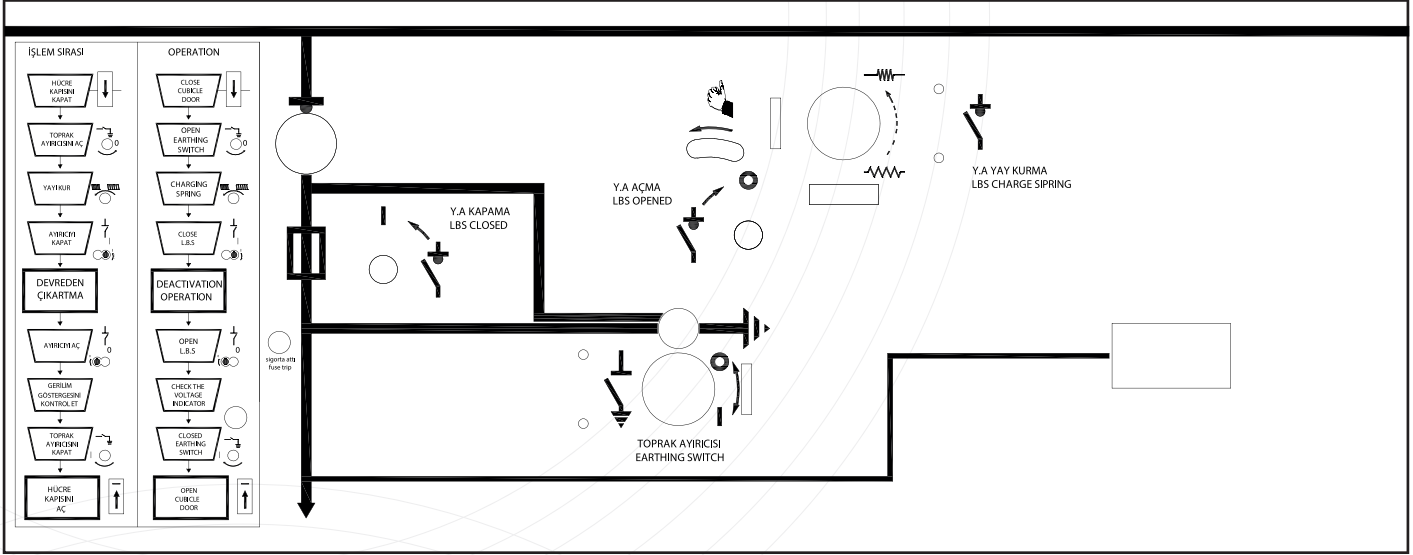

Hava Yalıtımlı Modüler Hücre Bölümleri

Hava Yalıtımlı Modüler hücre tipleri 3 ana bölümden oluşmaktadır. Bu bölümler anahtarlama ve mekanik kilitlemeler ile emniyeti sağlanmış olup, devamlılık sağlanacak geçişler diğer bölümlerden izole edilmiştir.

A – Alçak Gerilim Bölümü

Bu bölüm kontrol için tüm ikincil devreleri içerir (ölçüm, koruma, izleme, iletişim ve diğer ilişkili sistemler).

B – Kesici ve Kablo Bölümü

Kesici bölümünde aşağıdaki ekipmanlar kullanılır:

- Vakum Kesici - SF6 Kesici - SF6 Yük Ayırıcı
- SF6 Ayırıcı - Gerilim Trafosu - Akım Trafosu
- Orta Gerilim Sigorta - Kapasitif Gerilim Bölücü
- Kablo rakoru ve bağlantı parçaları

C – Bara Bölümü

Bara bölümünde anma akımına uygun olarak seçilen elektrolitik bakırlar, izolatörler ve geçit izolatörleri bulunmaktadır. Bu bölüme erişim özel talimatlar ve güvenlik tedbirleri gerektirir.

Air Insulated Modular Switchgear Section

Air Insulated Modular Switchgear consists of 3 main sections. These sections are secured with keys and mechanical locks. Alongside this, continuous transitions are isolated from the other sections.

A-Low Voltage Section

This section contains every secondary circuit for control (measurement, preservation, tracing, communication and other related systems).

B-Cutting and Cable Section

Following equipments are used in Cutting Section:

- Vacuum Circuit Breaker -SF6 Circuit Breaker -SF6 Gas Load Break Switch -SF6 Gas Disconnecter -Voltage Transformer -Current Transformer -Mid Voltage Fuse
- Capacitive Voltage Divider -Cable connector and connection components.

C-Busbar Section

Busbar section contains suitable electrolytic coppers, insulators and bushing insulators selected for nominal voltage. Access to this section requires special instructions and security precautions.

Odacık Tipi Focus Type		MH 12	MH 17.5	MH 24	MH 36
Anma Gerilimi	Nominal Voltage	12 KV	17.5 KV	24 KV	36 KV
Anma Akımı	Nominal Current	630-1250 A	630-1250 A	630-1250 A	630-1250 A
Anma Frekansı	Nominal Frequency	50-60 Hz	50-60 HZ	50-60 Hz	50-60 Hz
Kısa Süreli Akım Dayanımı(1sn)	Short Term Rated Current Resistance (1sec)	16-20-25 KA	16-20-25 KA	16-20-25 KA	16-20-25 KA
Anma Şebeke Frekanslı Dayanım Gerilimi(kv/1dk.)	Rated Grid Frequency Resistance Voltage (kv/1 min.)	28 KV	38 KV	50 KV	70 KV
Yıldırım Darbe Anma Gerilim Dayanımı 1.2/50us	Lightning Impact Nominal Resistance 1.2/50us	75 KV	95 KV	125 KV	175 KV
İç Ark Sınıfı	Internal Arc Classification	IAC-AFLR	IAC-AFLR	IAC-AFLR	IAC-AFLR
Koruma Sınıfı	Protection Classification	IP3X	IP3X	IP3X	IP3X



Hücre Tipi 36 KV Switchgear Type 36 KV	Yükseklik(mm) Height	Genişlik(mm) Width	Derinlik(mm) Depth	Ağırlık(kg) Weight
M-YGC	2250	750	1400	310
M-YSC	2250	750	1400	330
M-YAG	2250	1000	1400	590
M-GKC	2250	1000	1400	600
M-GKT	2250	1000	1400	600
M-GKK	2250	1500	1400	900
M-GAG	2250	1000	1400	590
M-GGT	2250	750	1400	460

Hücre Tipi 12-24 KV Switchgear Type 12-24 KV	Yükseklik (mm) Height	Genişlik (mm) Width	Derinlik (mm) Depth	Ağırlık (kg) Weight
M-YGC	1800-1950	375-500	1000-1200	140
M-YSC	1800-1950	375-500	1000-1200	150
M-YAG	1800-1950	750	1000-1200	400
M-GKC	1800-1950	750	1000-1200	410
M-GKT	1800-1950	750	1000-1200	410
M-GKK	1800-1950	750-1000	1000-1200	450
M-GAG	1800-1950	750	1000-1200	400
M-GGT	1800-1950	375-500	1000-1200	220

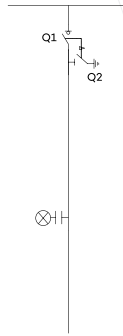
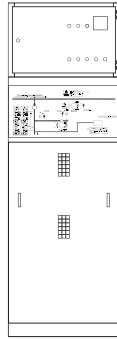
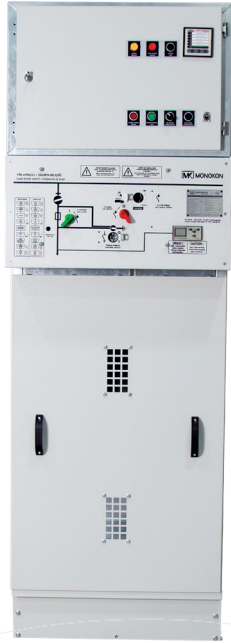

M-YGC

YÜK AYIRICILI GİRİŞ ÇIKIŞ HÜCRESİ
LOAD BREAK SWITCH INCOMING
OUTGOING UNIT

Un (kV)	36 kV	12/24 kV
En/Width (mm)	750	375-500
Boy/Height (mm)	1400	1000
Yükseklik/Length (mm)	2250	1935

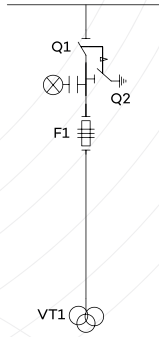
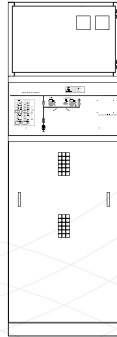

M-GGT

GERİLİM TRANSFORMATÖR HÜCRESİ
VOLTAGE TRANSFORMER CUBICLE

Un (kV)	36 kV	12/24 kV
En/Width (mm)	750	375-500
Boy/Height (mm)	1400	1000
Yükseklik/Length (mm)	2250	1935

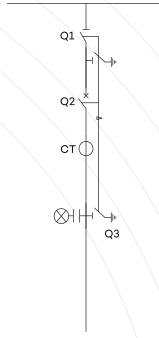
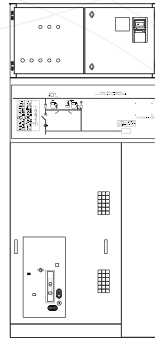

M-GKT

KESİCİLİ TRAFİ KORUMA HÜCRESİ
CIRCUIT BREAKER
TRANSFORMER PROTECTION UNIT

Un (kV)	36 kV	12/24 kV
En/Width (mm)	1000	750
Boy/Height (mm)	1400	1000
Yükseklik/Length (mm)	2250	1935

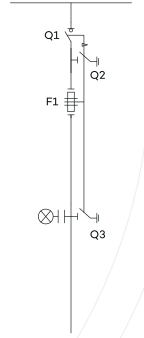
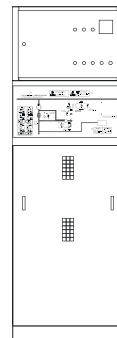

M-YSC

YÜK AYIRICILI SİGORTALI TRAFİ
KORUMA HÜCRESİ
FUSE LOAD BREAK SWITCH
TRANSFORMER PROTECTION UNIT

Un (kV)	36 kV	12/24 kV
En/Width (mm)	750	375-500
Boy/Height (mm)	1400	1000
Yükseklik/Length (mm)	2250	1935

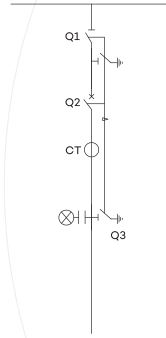
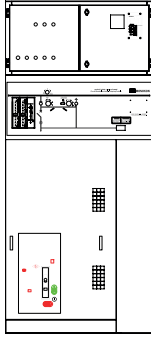

M-GKC

KESİCİLİ GİRİŞ ÇIKIŞ HÜCRESİ
CIRCUIT BREAKER INCOMING
OUTGOING UNIT

Un (kV)	36 kV	12/24 kV
En/Width (mm)	1000	750
Boy/Height (mm)	1400	1000
Yükseklik/Length (mm)	2250	1935

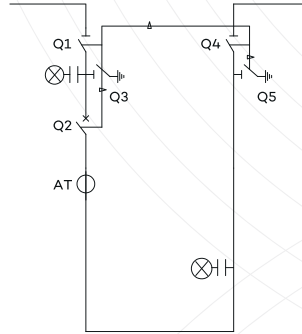
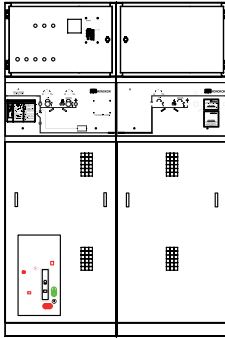

M-GKK

KESİCİLİ KUPLAJ (ÇİFT AYIRICILI) HÜCRESİ
BUS COUPLING WITH CIRCUIT
BREAKER UNIT

Un (kV)	36 kV	12/24 kV
En/Width (mm)	1500	750-1000
Boy/Height (mm)	1400	1000
Yükseklik/Length (mm)	2250	1935

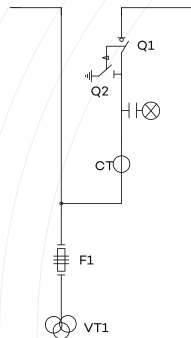
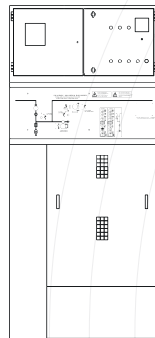

M-YAG

YÜK AYIRICILI AKIM GERİLİM ÖLÇÜ HÜCRESİ
VOLTAGE & CURRENT
MEASUREMENT UNIT WITH LBS

Un (kV)	36 kV	12/24 kV
En/Width (mm)	1000	750
Boy/Height (mm)	1400	1000
Yükseklik/Length (mm)	2250	1935



KOMPAKT

TRAFIK
MERKIZI



● MBK SERİSİ | MKS SERİSİ | MKM SERİSİ
(MBK SERIES | MKS SERIES | MKM SERIES)



MBK Serisi Beton Köşkler

MBK serisi OG-AG Prefabrik Monoblok Beton Transforma-tör ve Dağıtım Merkezleri, OG-AG elektrik tesisleri için ta-sarlanmış, ilgili uluslararası standartlara ve şartnamelere göre üretilen ürünlerdir.

Kullanım Alanları

Elektrik üretim (RES/HES), iletim ve dağıtım tesisleri ile en-düstriyel ve ticari tesislerde

- OG/AG Transforma-tör merkezi
- OG Dağıtım merkezi
- AG Pano kabini
- Jenera-tör kabini olarak kullanılmaktadır.

Avantajlar

Tip testleri ile kanıtlanmış iç ark dayanımı ve koruma sınıfı ile sağlanan personel güvenliği fabrika ortamında montajı yapılmış ve test edilmiş donanım ve iç topraklama sistemi standartlara uygun ve yüksek kaliteli elektriksel donanım kullanımı uzun ömürlü çevre koşullarına dayanıklı sağlam mahfaza, asgari tesis alanı ihtiyacı ve inşaat işleri kolay kurulum ve hızlı devreye alma taşınabilirlik sınırsız renk ve yüzey kaplama seçeneği ile çevreyle uyumlu estetik yap-dır.

İç Topraklama ve Aydınlatma Sistemi

Beton mahfazanın çelik donatısı, kapı ve elektrik teçhiza-tının topraklama terminalleri ve topraklanması gereken di-ğer bütün metal parçalar standart ve şartnamelerde belir-tilen iletkenler kullanılarak potansiyel dengeleme barasına (bakır) taşınmaktadır

MBK Series Concrete Substation

MBK series OG-AG Prefabricated Monoblock Concrete Transforma-tör and Distribution Centers, are designed for electric facilities, they are produced accordingly to meet the international standarts and requirements

Usage Areas

Used in industrial and commercial facilities for power ge-neration (RES/HES), communication and distribution as with the following,

- OG/AG Transforma-tör center
- OG Distribution center
- AG Panel cabin
- Genera-tor cabin

Advantages

- Internal arc resistance proven by type testing and personnel safety provided by protection classifications.
- Assembled in factory environment and tested hardware with internal earthing system.
- Standardized and high quality electrical equipment durable to weather conditions.
- Easy installation process.
- Portability with endless option of colors and surface coating in order to match the surroundings.

Internal Grounding and Lighting System

The steel reinforcement of the concrete casing, the ground terminals of the door and electrical equipment and all ot-her metal parts that need to be grounded are conveyed to the potential equalization busbar (copper) using the con-ductors specified in the standards and specifications.

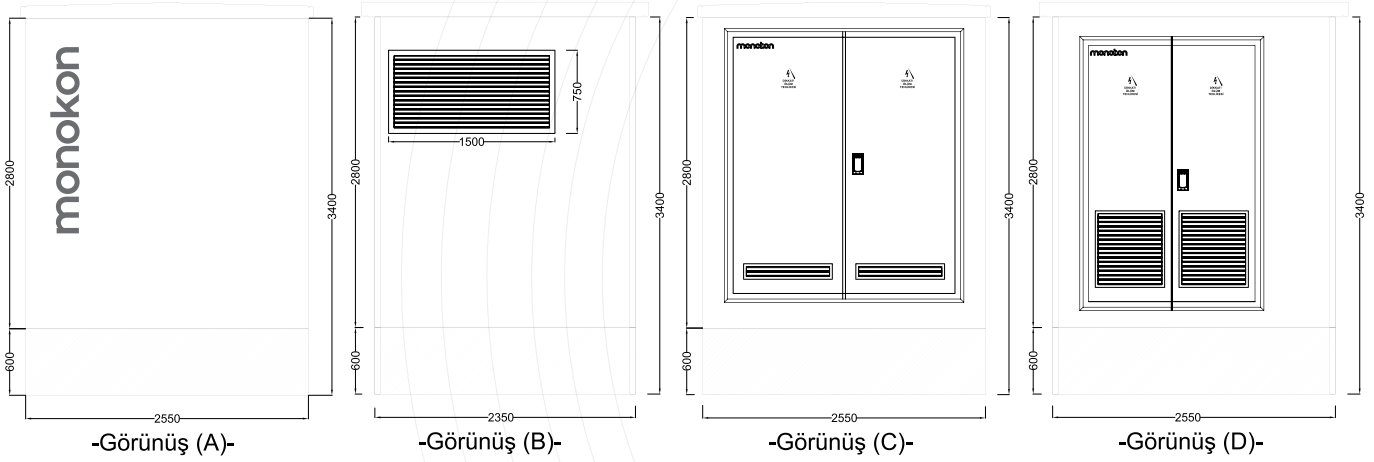

Anma Değerleri

Nominal Values

İşletme Gerilimi (Azami)	Operation Voltage (Maximum)	36 kV
Transformatör Gücü (Azami)	Transformer Capability (Maximum)	1600 kVA
Yalıtım Seviyesi	Insulation level	70 / 170 kV
Kısa Devre Dayanım (OG-AG)	Resistance to short circuit (OG/AG)	16 kA / 38 kA
İç Ark Sınıfı	Internal Arc class	AB
Frekans	Frequency	50 / 60 Hz
Koruma Sınıfı	Protection class	IP23D
Mahfaza Sınıfı	Case class	10
Beton Sınıfı	Concrete class	C35 / 45

Rakım	Altitude	2000m
Ortam Sıcaklığı	Ambient temperature	-25...+50 ° C
Ortam Kirliliği	Ambient pollution	Düzyer 3
En Yüksek Güneş Işınımı	Highest Sun Radiation	1000 W / m ²
Bağıl Nem (Azami %)	Relative humidity (Maximum %)	95
Yer Sarsıntısı İvmesi (Y / D)	Earthquake acceleration (Y/D)	0.5g / 0.4g
Sistem Topraklaması	System Earthing	Direnç üzerinden topraklı veya direkt topraklı

Ürün Tipi Product Type	Uzunluk (mm) Length (mm)		Genişlik (mm) Width (mm)		Yükseklik (mm) Height (mm)		Ağırlık (ton) Weight (ton)
	A (DIŞ)	B (İÇ)	DIŞ	İÇ	DIŞ	İÇ	
MBK 2550	2550	2350	2500	2300	3550	3340	BOŞ 9
MBK 3800	3800	3000	2500	2300	3550	3340	12
MBK 4500	4500	3800	2500	2300	3550	3340	13
MBK 5500	5500	4300	2500	2300	3550	3340	14
MBK 6450	6450	5300	2500	2300	3550	3340	22
MBK 7500	7500	7300	2500	2300	3550	3340	25

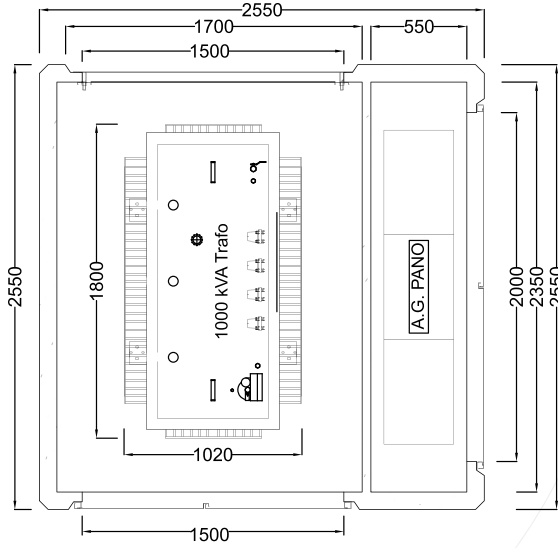

MBK 2500/1000



MBK 2500/1600

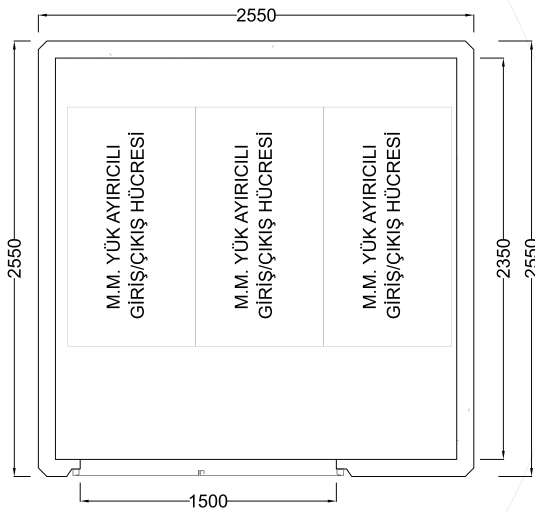
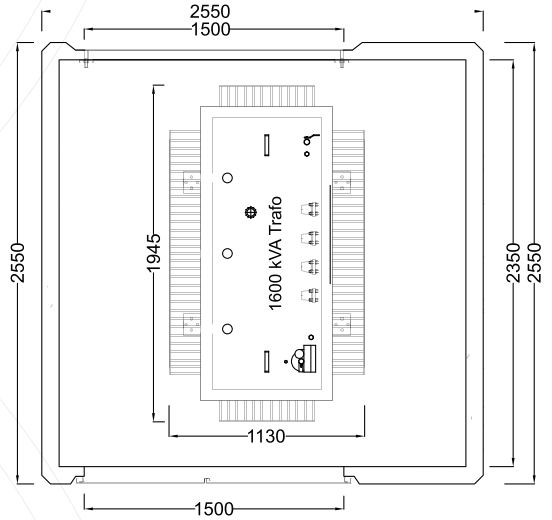

MBK 2500/DM

MBK 3800/1000

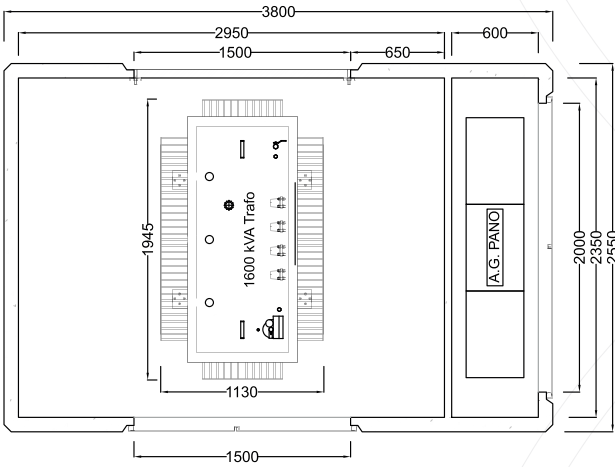
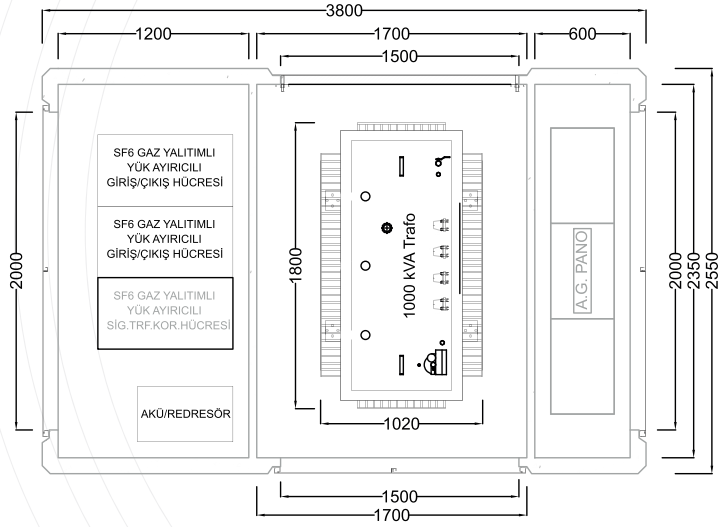

MBK 3800/1600



MBK 3800/DM

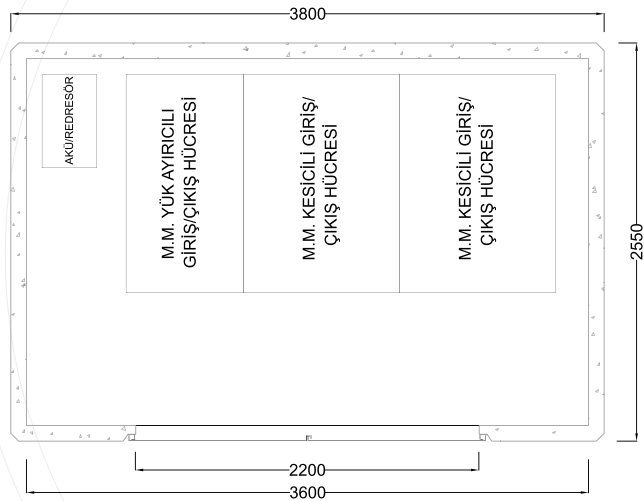

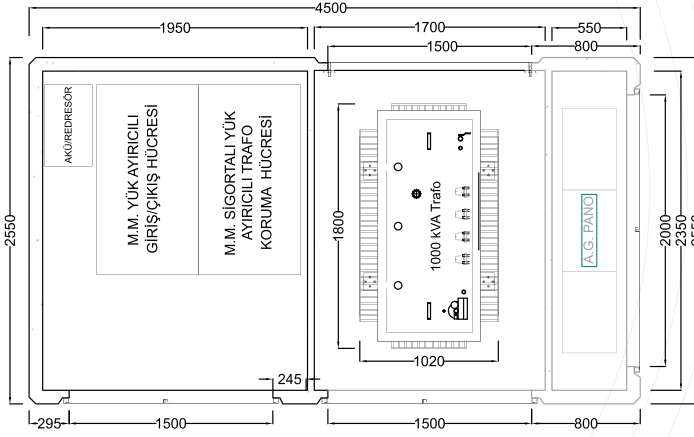

MBK 4500/1000



MBK 4500/DM

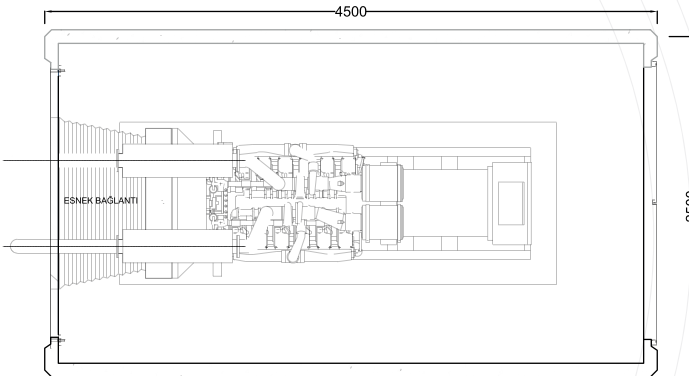
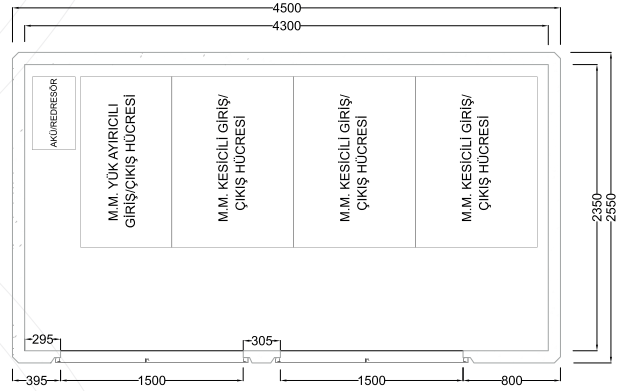

MBK 4500/J

MBK 5500/1000

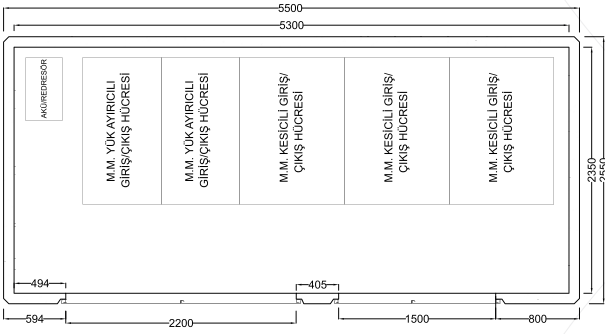
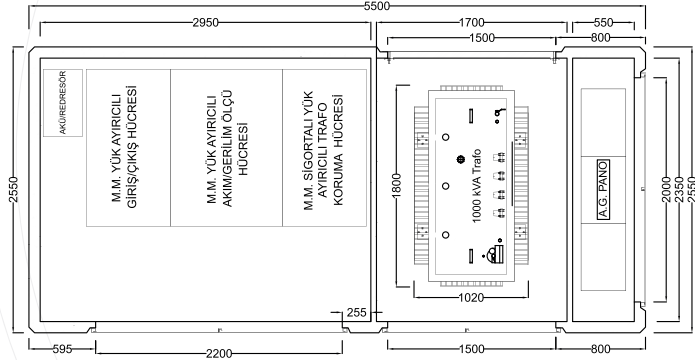

MBK 5500/DM



MBK 5500/J

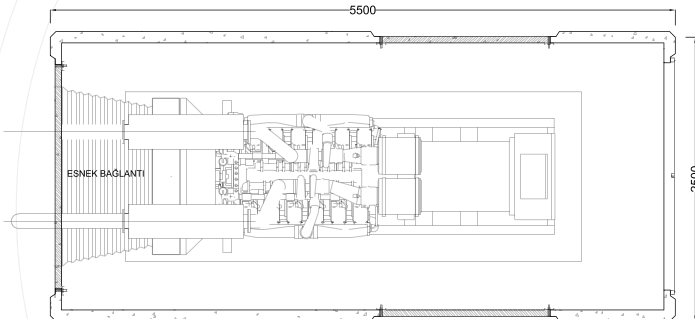

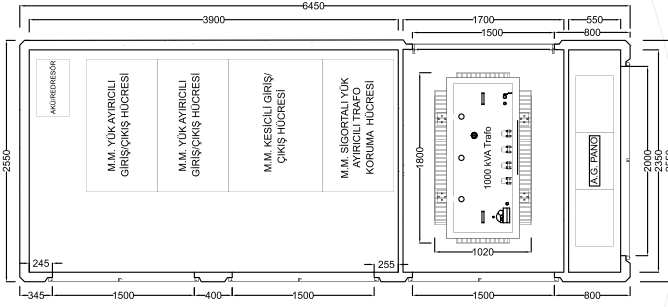

MBK 6450/1000

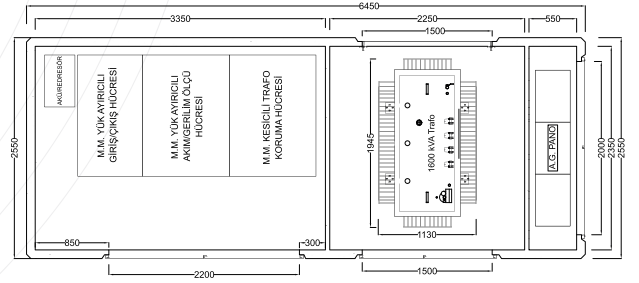

MBK 6450/1600

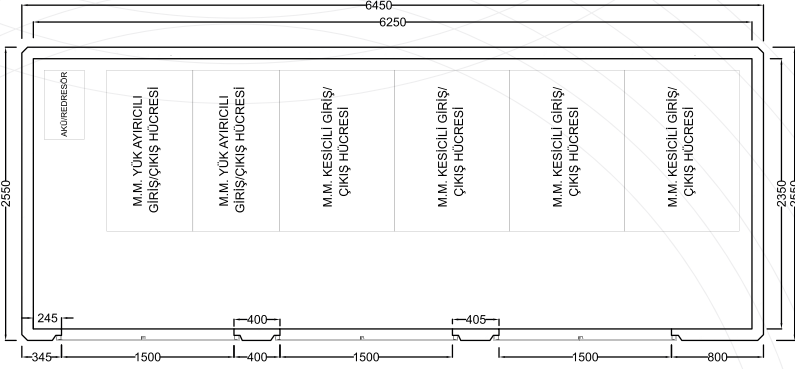

MBK 6450/DM

MBK 6450/J

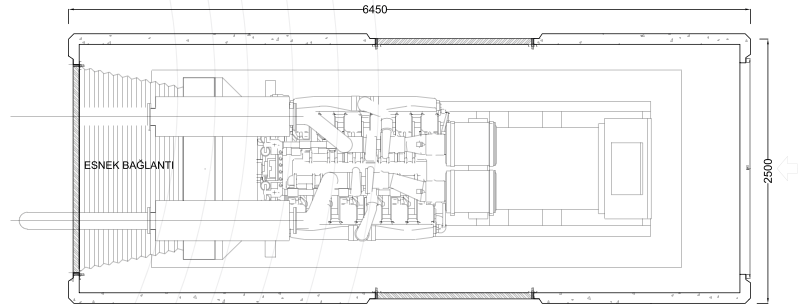

MBK 7500/1000

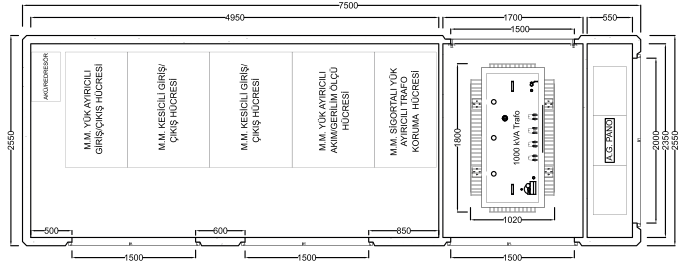

MBK 7500/1600

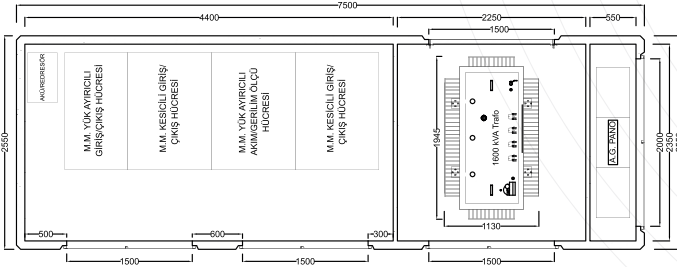

MBK 7500/DM

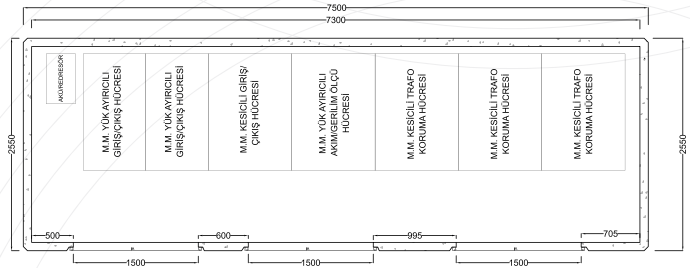

MBK 7500/J

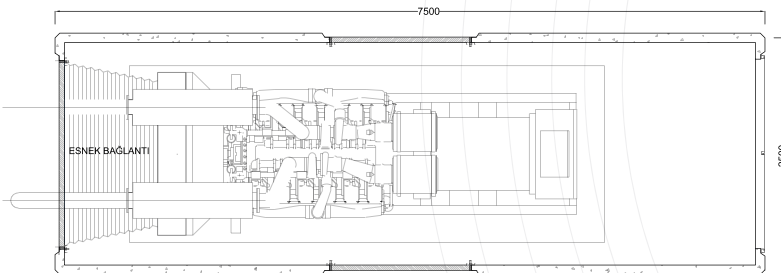



Teknik Özellikler
Technical Features

Anma Gerilimi (Minimal Voltage)	11-35 kV
Maksimum Beyan Gücü (KVA) (Maximum Power (KVA))	2500 KVA
Boyutlar (metre) (Dimensions(meters))	2-40 m
Koruma Sınıfı (Protection Class)	IP65
Boya (Coating)	Elektrostatik

MKS Serisi Sac Köşkler

Mks serisi sac köşkları tüm uygulama alanları için istenilen ölçülerde galvanizli ve elektrostatik toz boyalı sacdan imal edilen trafo ve dağıtım merkezleridir. Tüm iklim şartlarında kullanılabilecek olan Monokon Elektrik sac köşkları (trafo merkezi) elektrik dağıtım şirketlerinin ve özel projelerin orta gerilim-alçak gerilim (OG-AG), dağıtım merkezi ihtiyaçlarını karşılamaktadır.

MKS Series Sheet Kiosks

MKS Series sheet kiosks are transformer and distribution centers fabricated from galvanized and electrostatic powder coated sheets in order to meet the needs of all kinds of application areas. Monokon Electric sheet kiosks(transformer station) which are usable in every climate condition supplies the mid -low voltage(OG/AG) and supply station needs for electric supply companies and private projects.

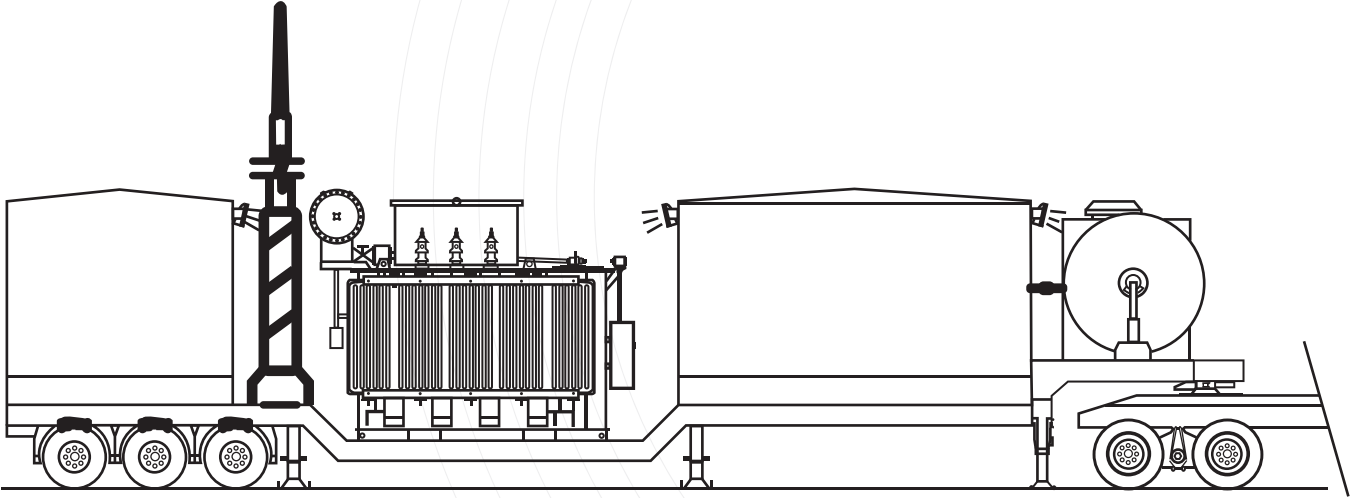

MKM Serisi Mobil Trafo Merkezleri

OG/AG-MKM serisi Mobil İstasyonlar proje ihtiyaçlarına uygun olarak, müşterinin özel isteklerini karşılayacak şekilde, şirket deneyimlerimizle, projeye özel şartname ve ilgili standartlara uyularak üretilen gezici istasyonlardır.

İstasyonun projelendirilmesi ve imalat sırasında saha ve ulaşım şartları analiz edilerek, Treyler, Römork, Kızak veya Vagon üzerine inşa edilirler.

Sabit bir istasyonun işletilmesi için gerekli tüm ürünlerle donatılmış ve bu ürünlerin işletmeye hazır halde elektriksel / mekaniksel bağlantılarının yapılmış olmasının yanı sıra mobil yapısı sayesinde kolayca yer değiştirilebilirliği öne çıkan tercih sebeplerindedir.

MKM Series Mobile Transformer Substations

OG/AG – MKM series mobile substations are designed to fulfill the special requests of our clients, based on the needs of their project. They are mobile stations produced by our company's experiences in compliance with private specifications and related standards.

Mounted on skids, trailers or wagons after analyzing the field and transportation conditions during the station planning and manufacturing.

Besides the fact that it is equipped with every component and ready to operate complete assemblies that are needed to operate a stationary station, its mobile structure and easy to relocate feature makes it a prominent choice.

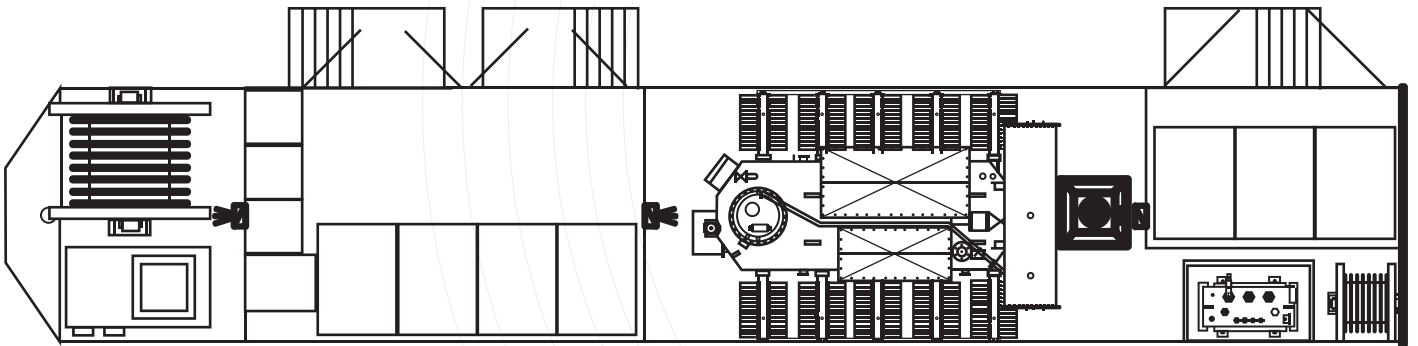

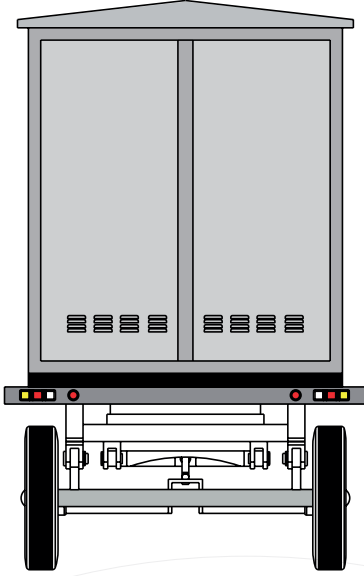

Genel Bölümleri

Orta Gerilim Bölümü:

- 1-52 kV Metal Bölmeli Hücreler, Metal Mahfazalı Hücreler veya Gaz İzoleli Hücreler

Trafo Bölümü:

- 400-4000 kVA Dağıtım Trafosu

Açık Gerilim Bölümü:

- 630-6300 A Açık Gerilim Dağıtım Panosu / Kompanzasyon Panosu ve Ölçü Panosu
- DC Dağıtım Panosu

Akü ve Akü Şarj Aleti Bölümü:

- Akü, Akü Rafları ve Şarj Aletleri

Diğer Bölümleri:

- Kontrol ve Kumanda Bölümü / Jeneratör Bölümü

General Sections

Mid Voltage section:

-1-52 kV Metal Enclosed Switchgears, Metal Clad Switchgears or Gas Isolated Switchgears

Transformer Section :

-400-4000 kVA distribution transformer

Low Voltage Section :

-630-63000 A low voltage distribution panel / Compensation panel and measure panel.
-DC supply panel

Battery and Battery Charging Section:

-Batiery, Batiery Trays and chargers.

Other Sections:

-Control and command section / Generator Section

Genel Özellikleri

IP56 koruma sınıfında kabin Treylar / Römork / Kızak / Vagon üzerine montaj Scada Sistemi dahil sabit bir istasyonda bulunan tüm ekipmanın mekaniksel / elektriksel montajı ve kullanıma hazır teslim edilmesi Güvenlik ekipmanları ve Devreye alma için gerekli ekipmanların istasyonda hazırda bulundurulması ile çok hızlı devreye alma ve işleme hazır hale getirilmeleri.

İçerisinde Barındırabileceği Ürünler ve Hizmetler

Orta Gerilim Hücreleri, Dağıtım Trafosu, Dağıtım Panosu, Ölçüm Panosu, Kompanzasyon Panosu, Ölçüm Panosu, Kumanda ve Kontrol Panosu, DC Dağıtım Panosu, Scada Sistemi, Jeneratör, Akü Rafları, Akü, Akü Şarj Aletleri, İletken ve İletken Bağlantı Elemanları, Aydınlatma ve İç İhtiyaç Tesisatı, Mekaniksel Montajlar, Elektriksel Montajlar, Uyarı ve İkaz Etiketleri, Test Aletleri, El Aletleri, Güvenlik Malzemeleri, Yangın Alarm ve Söndürme Sistemi, Merdiven veya Platform.

General features

IP56 protection class cabin mounted on skids, trailers, wagons including Scada System every equipments mechanical and electrical montage and ready to use delivery with safety equipments and their ability to that are also exists in stationary stations

Products and Services Situated Inside

Mid voltage switchgears, Distribution transformer, Supply panel, Compansation Panel, Measure Panel, Control and command Panel, DC Supply panel, Scada Systems, Generator, Battery trays, Battery, Battery chargers, conductive elements, Lightning and internal needs installation, Mechanical montages, Electrical montages, Warning and caution tags, Test tools, hand tools, Safety materials, Fire alarm and fire extinguishing system, ladder or platform.

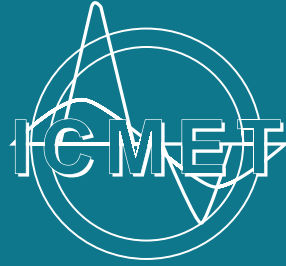

İletişim / Contact

+90 332 502 17 17

info@monokon.com.tr

www.monokon.com.tr

Büyükkayacık
4. OSB Mah.
408 Sk. No: 5
Selçuklu/KONYA

f t @ in / monokonelektrik